

USB Adaptor

User Manual



Free calls over internet with analogue telephone

1. Instruction

1.1 Summary

USB Adaptor is analog telephone adaptor with one USB interface to PC, 1 FXS for regular phone and 1FXO for PSTN call relays. All cordless phones and regular phones can be used to make and receive Skype call. Phone can be used to make regular call at the same time. Phone rings for all incoming skype and PSTN calls. Skype or PSTN calls is switched by pressing phone key(*).

1.2 Features

1. Supporting DECT, 2.4G, 900M and any other wireless phones
2. Make/Receive both Skype calls and regular PSTN calls
3. Auto-detection and auto-switching to Skype or PSTN calls
4. Phone rings for all incoming Skype and PSTN calls
5. Skype or PSTN calls switched by pressing phone key(*)
6. Using the phone keypads to dial.

1.3 System Requirements

1. Windows 2000 or XP
2. 400MHz processor and free USB1.1 or USB2.0 port
3. 128MB RAM and 15MB free disk space
4. Any broadband connection or minimum 33.6 Kbps dialup

1.4 Package Contents

1. one USB Adaptor
2. one USB Cable
3. one Telephone Line
4. one User Manual
5. one Installation CD

2 Using the USB Adaptor

2.1 Connect USB Adaptor to PC

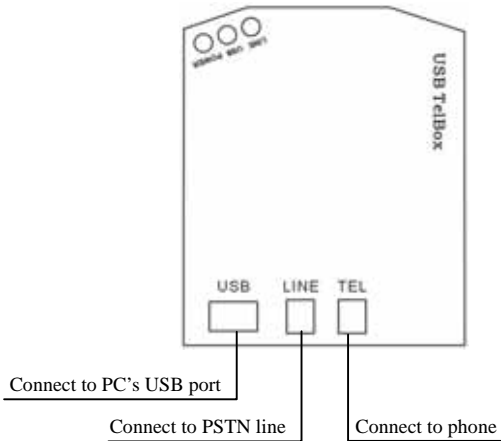

- Connect USB Adaptor to PC, POWER indicator will be on.
- Plug PSTN line in "LINE" port.
- Connect Phone to "TEL" port.

2.2 Run Skype

- Download Skype software and install it (www.skype.com), the version must be 1.0.0.106 or higher.
- Run Skype and login with Skype account.

You can create a Skype account as shown below:



After the software startup, the icon will appear to the system tray as shown below:



That indicates the Skype is connected to Internet. If it is not, the icon will be shown as . Then you have to check whether PC is connected to internet successfully or not.

2.3 Run SkypeMate

- Insert SkypeMate Installation CD or download SkypeMate software, and install it.
- Run SkypeMate

Double-click the icon  on the desktop, the Skype program will pop up the window as shown below:



Select the first option “Allow this program to use Skype”, click “OK” button.

Note: If you selected the wrong option, you can make another selection. Please see **2.9. FAQ /problem3** for detail.

After running SkypeMate, the icon will appear to the system tray as shown:



That indicates the device and Skype are connected successfully.

If the icon shown as  (the phone is green and the outside is grey), please run Skype first.

If the icon shown as  (the phone is red and the outside is green), it means USB Adaptor connected incorrectly. Please reconnect USB Adaptor to PC.

Note: When SkypeMate startup, the default channel is PSTN.

2.4 Channels Switch

You can press “*” to switch PSTN channel to USB channel or switch USB channel to PSTN channel.

2.5 Call another Skype user (PC to PC)

- ▣ Add "bbc456" to Contacts
- ▣ Assign Speed-Dial for it, for example "11"

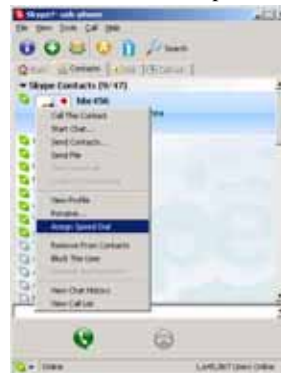

- ▣ Input number and call out:
Press “*” to switch to USB channel, the "USB" indicator is on. Press digital "11" on the phone, this number will be shown on Skype window, and then press “#” to call out. When you hang up, the USB Adaptor switch to PSTN channel automatically.

2.6 Call to regular phone (PC to Phone)

Pressing "00"+"country number"+"phone number"+"#" can start the Skype out.

Example: call to China, beijing, press 00861012345678, then press "#".

0086	10	12345678
-----	-----	-----
country code	city code	destination number

Note: If you want to use this function, you should buy SkypeOut Credit first.

2.7 Make calls through PSTN (Phone to Phone)

Check the PSTN indicator is on, then press the wanted phone number, and press "#". If the PSTN indicator is off, press "*" key to make it on.

Example: call to China beijing 00861012345678

Operation: Input the number 00861012345678, then press "#". to call out.

2.8 Answer a call

When a call come in, the phone will be ringing. Pick up handset or press handfree key to answer the call.

2.9 FAQ

Problem 1

There is no voice comes out when play music?

Resolution

Please execute the "Control Panel->Sound and Video (👉) ->Audio", set **Sound Playback** and **Sound Recording's** Preferred device to your sound card as shown below:



Problem 2

The voice is played from the PC's sound card instead of the USB Adaptor when I make/answer a call?

Resolution

Execute "Tools->Options->Sound Devices" to open the window as below:



Set “Audio In” and “Audio Out” to “USB Audio Device”.

Problem 3

Skype has been startup, but the icon of SkypeMate still shown as  (the phone is green and the outside is grey)?

Resolution

Maybe you have selected the wrong option. You can execute “Tools-> Options-> Privacy-> Manage other programs’ access to Skype”, then choose the needed option, click “Change” button to open the “Manage API Access Control” windows, and make another selection.